

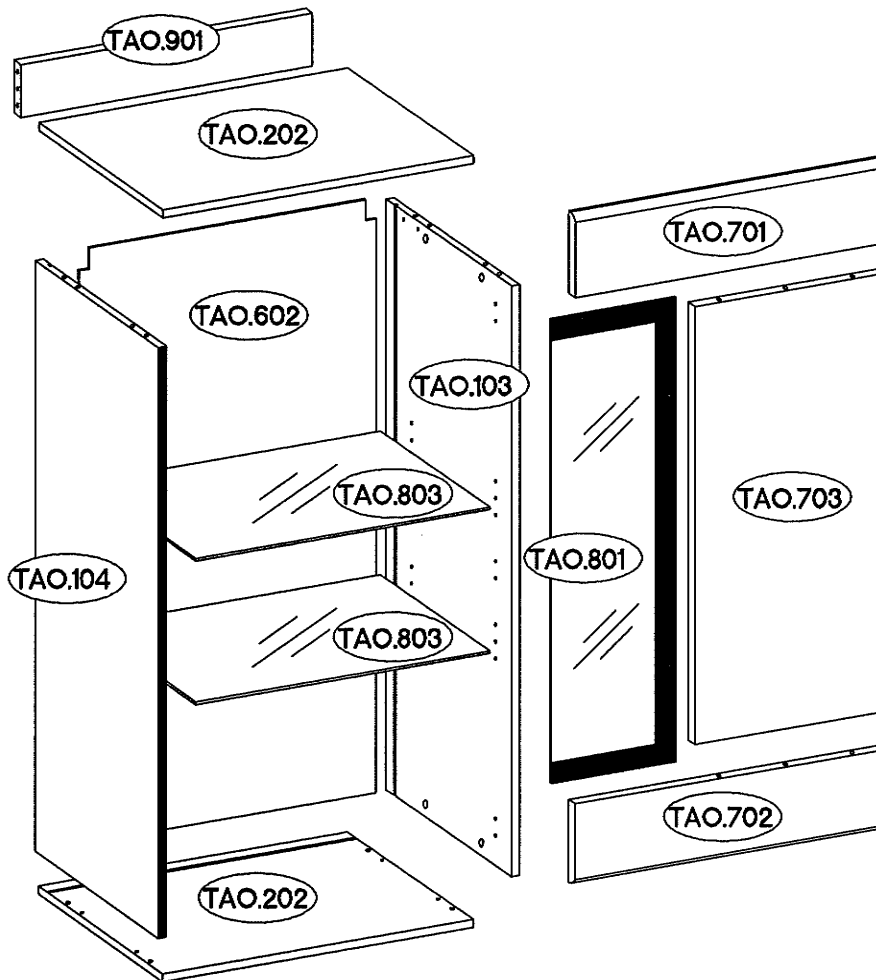

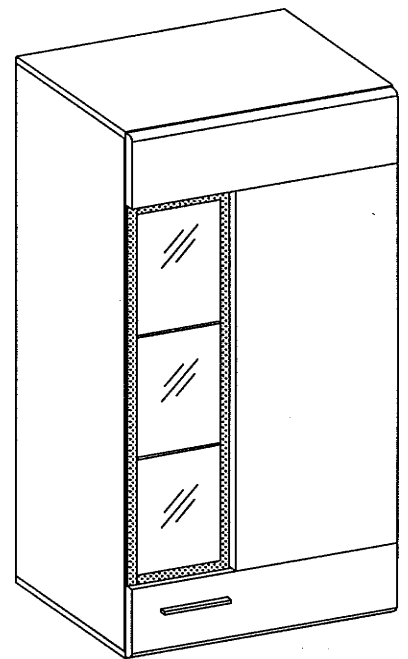



















TANGO 531







TAO.803 = max. 2kg

TAO.202 = max. 5kg

 L-20mm D2	 #5/12mm C	 #8x30mm A	 H-0 H	 #35/0mm G	 #3.5x13mm P5	 #8x60mm A2	 K	 #4.0x30mm P8	 #10x50mm O7	 #4.0x16mm R11	 #7/4mm J7
10	14	12	3	3	6	4	2	4	2	2	2
 L	 E	 L-128mm S1	 #4.0x30mm R2	 6,5/68mm O4	 O1	 L-58mm J23	 D4	 J12			
6	12	1	2	2	1	5	2				8

1

 f15/12mm C	 f8x60mm A2	 L-56mm O1	 D4
4	4	1	2

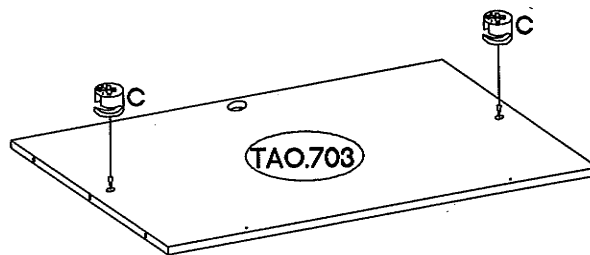
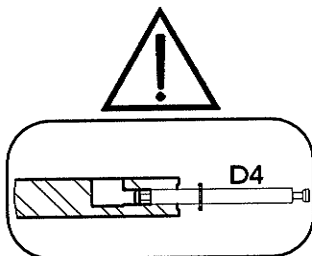
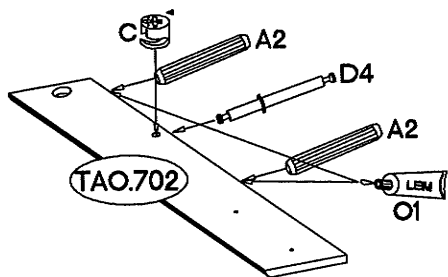
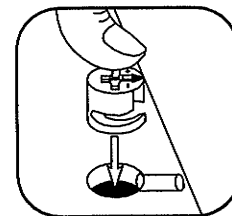
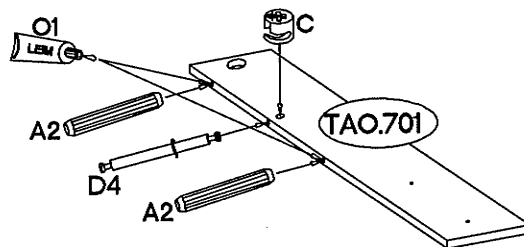

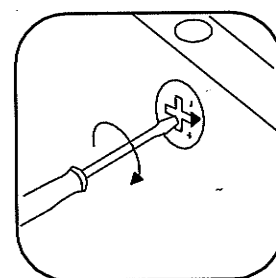
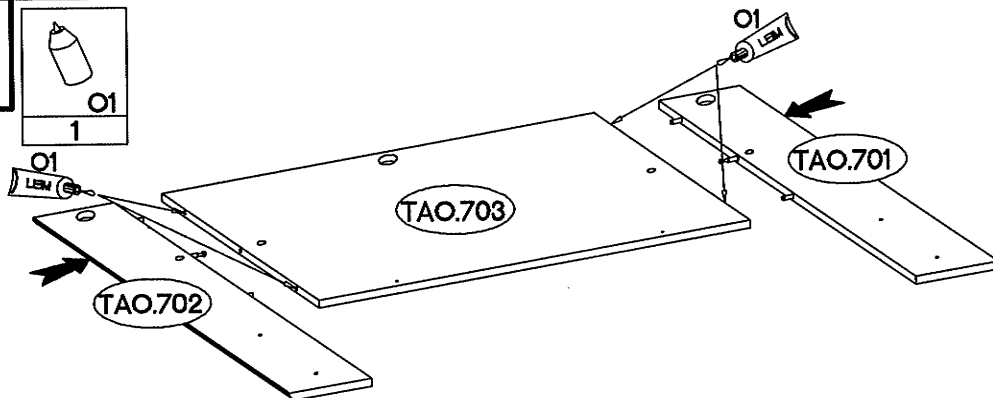

2

 O1
1



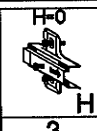

3

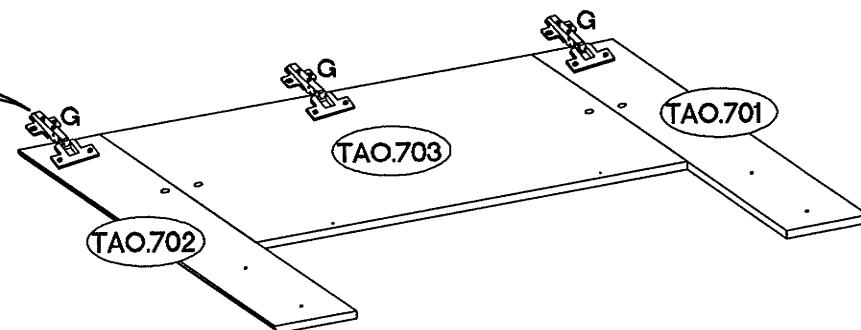
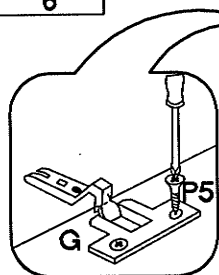
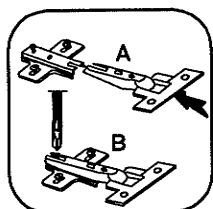
 H-0 H	 f35/0mm G	 f3.5x13mm P5
3	3	6



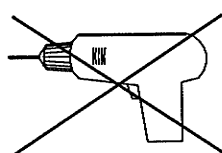
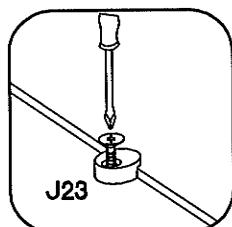

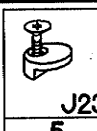
4

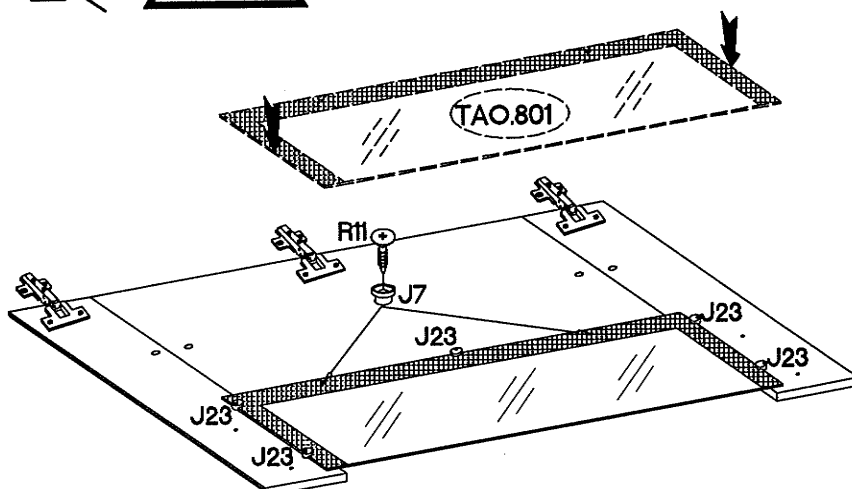
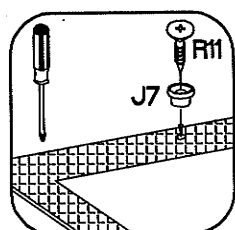

 f4.0x16mm J23	 f7/4mm R11	 J7
5	2	2

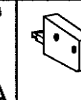
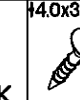

5

 L=20mm D2 10	 f16/12mm C 10	 f8x30mm A 12	 K 2	 f4.0x30mm P8 4
---	--	---	--	---

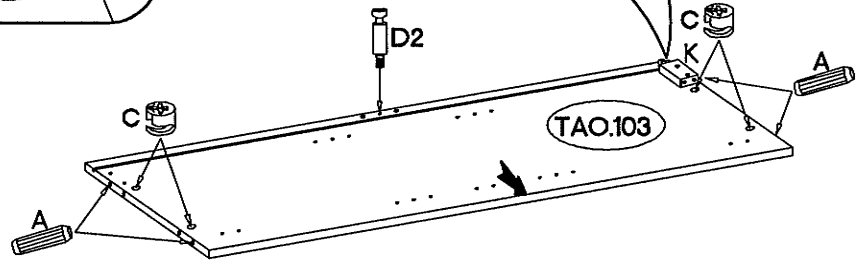
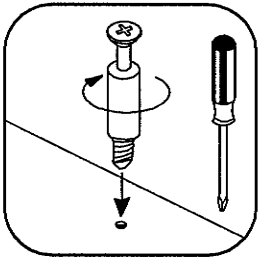
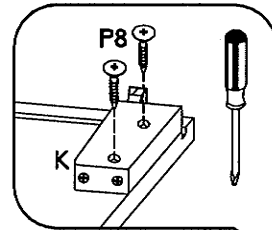
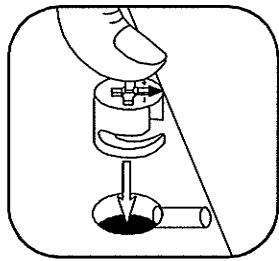
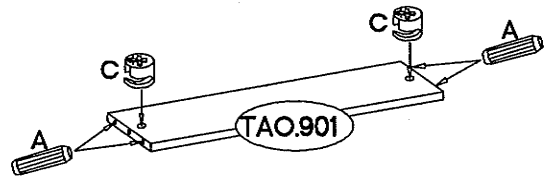
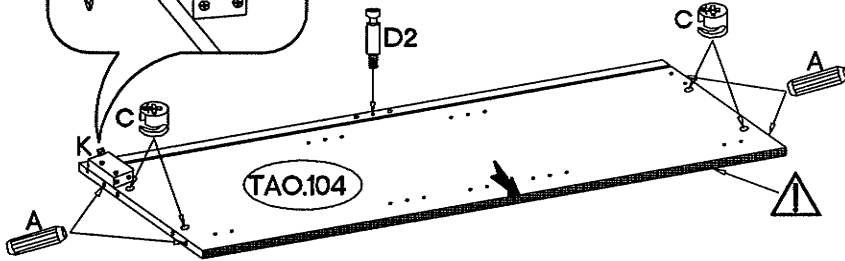
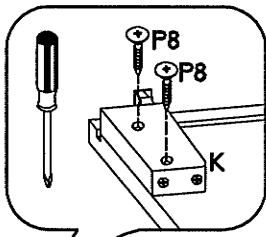
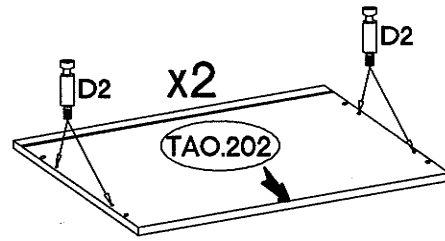

6

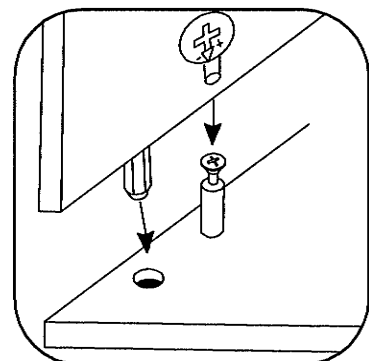
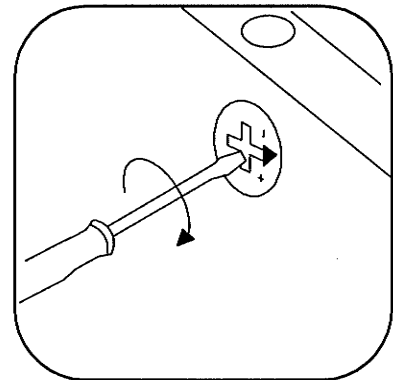
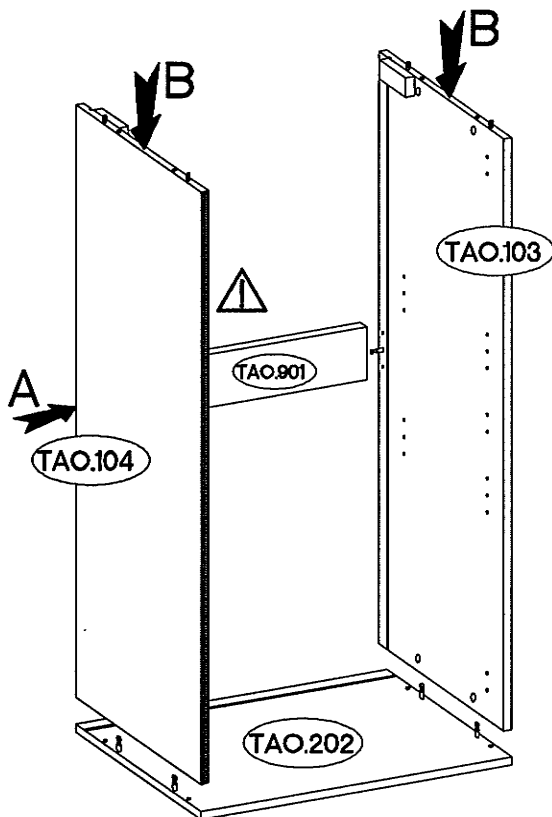

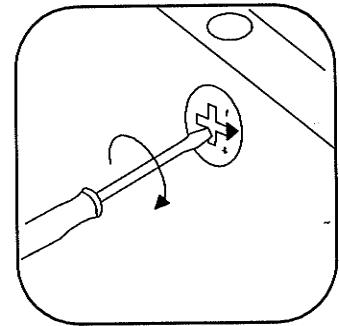
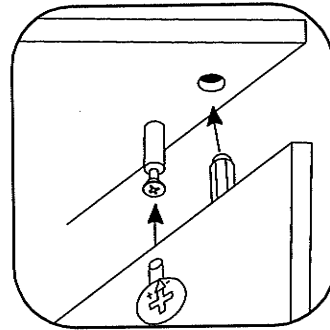
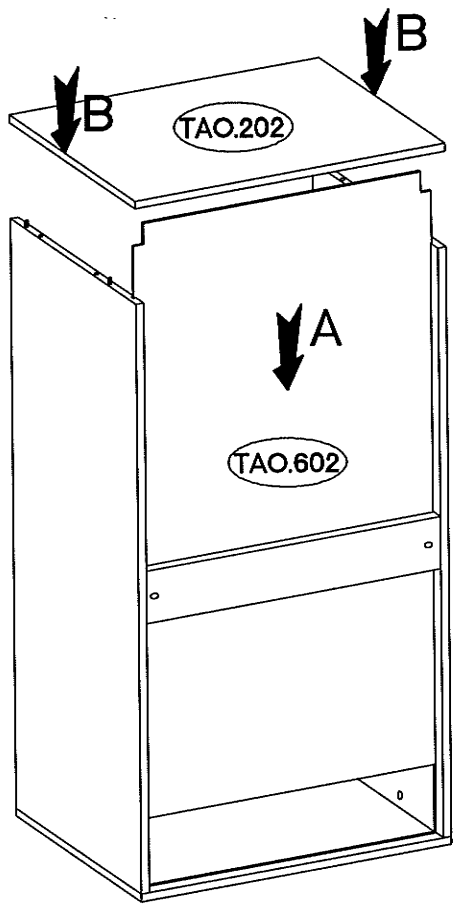

7

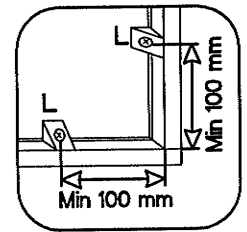
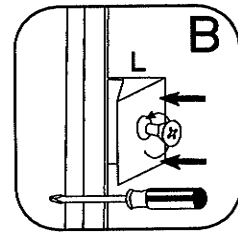
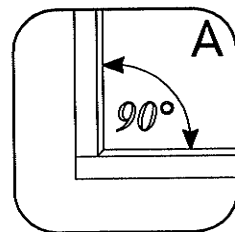
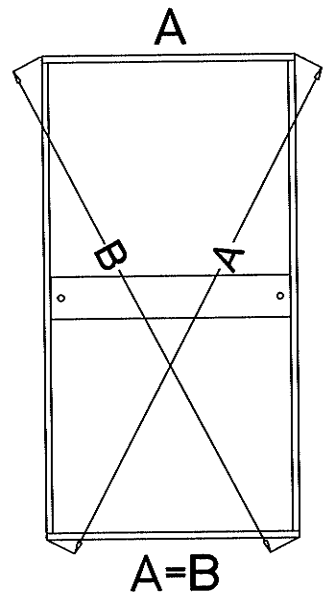
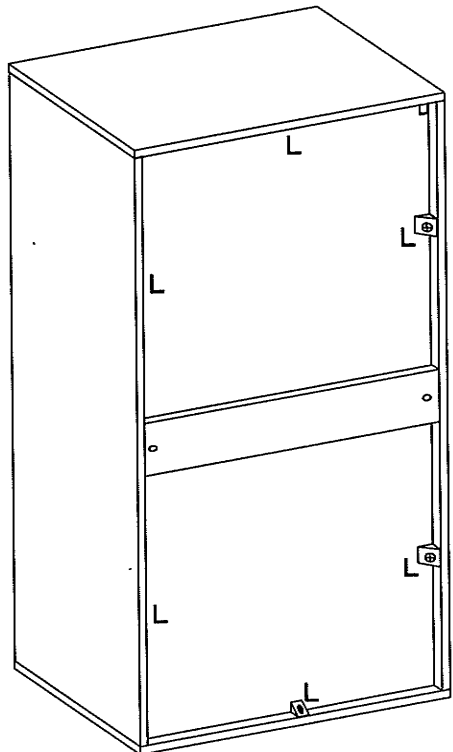
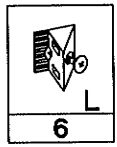

8



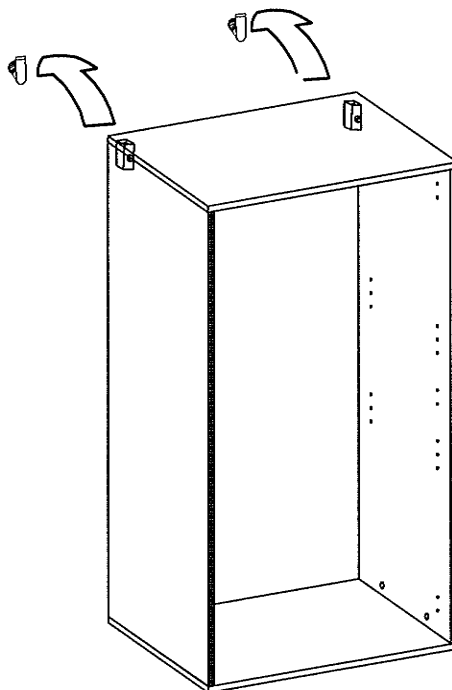
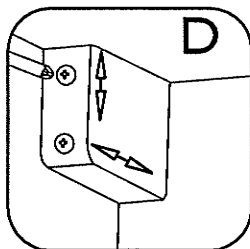
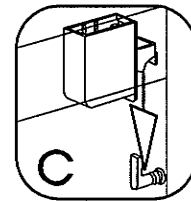
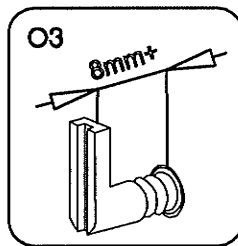
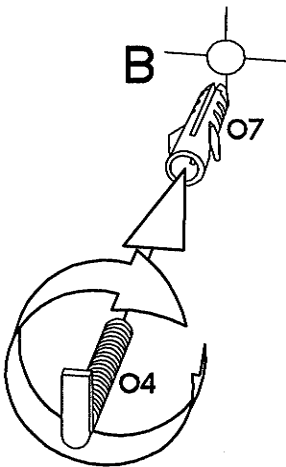
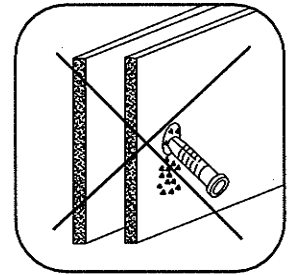
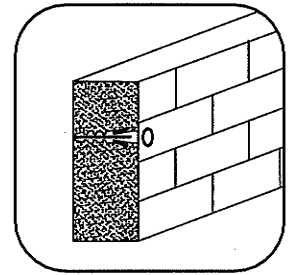
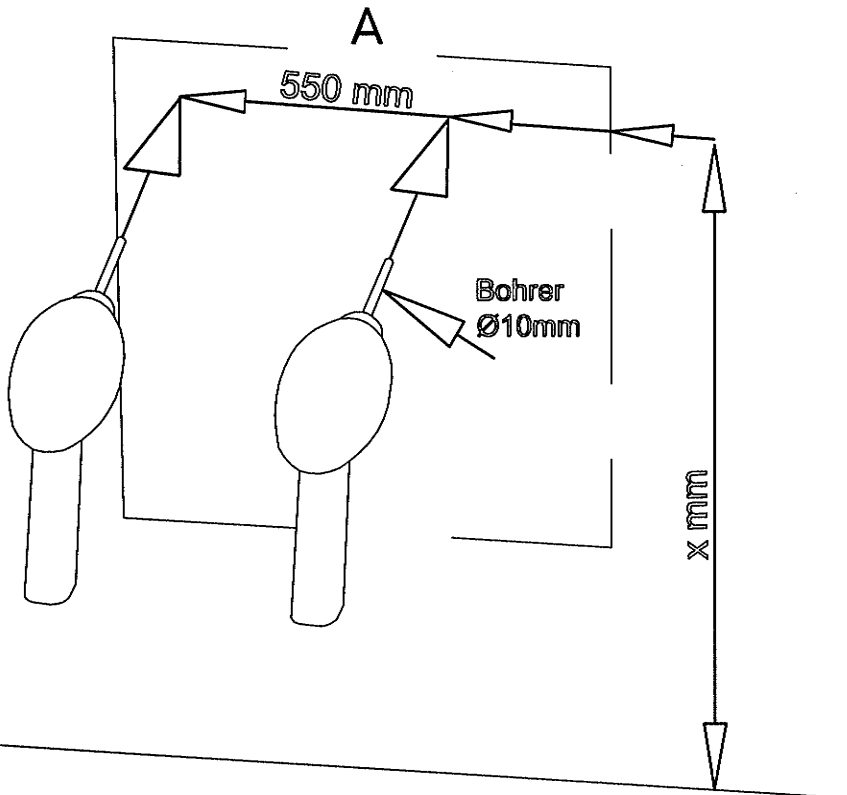

9

110x50mm	6,5/68mm
	
O7	O4
2	2

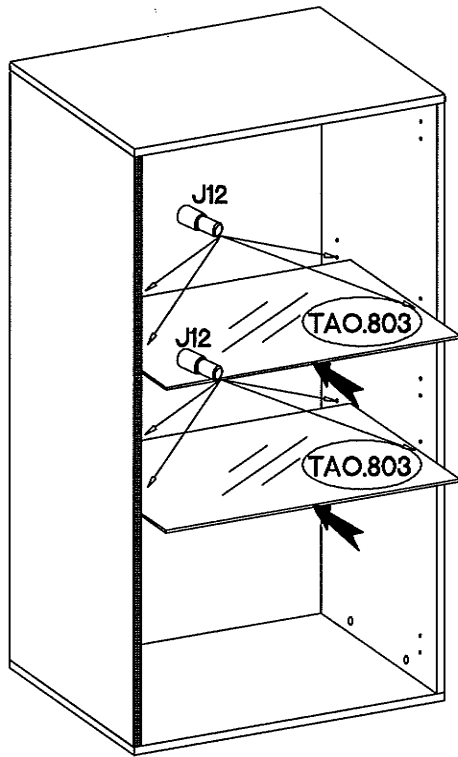

10



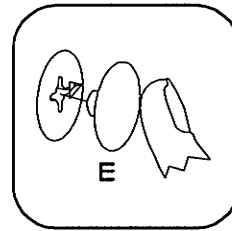
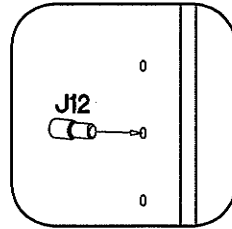

	
E	J12
8	8

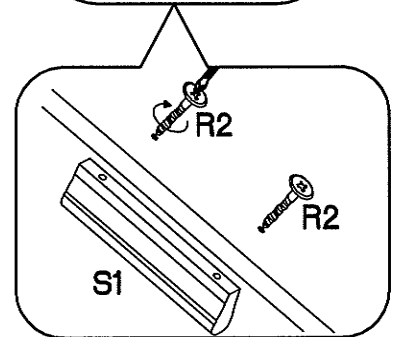
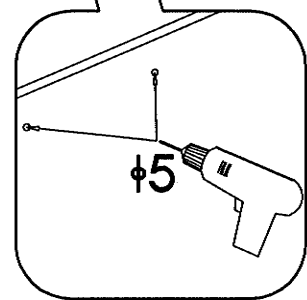
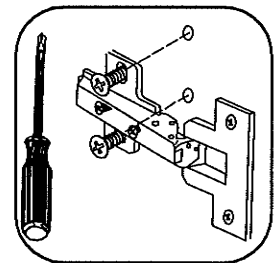
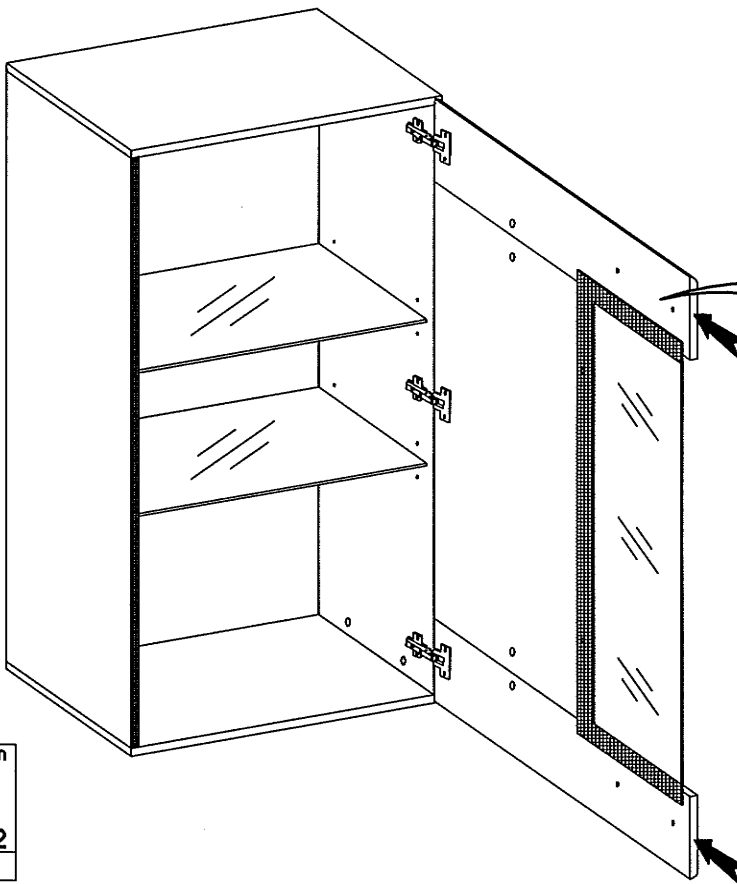

11



	E
4	
L=128mm	φ4.0x30mm
	
S1	R2
1	2

