

# NKSZ160

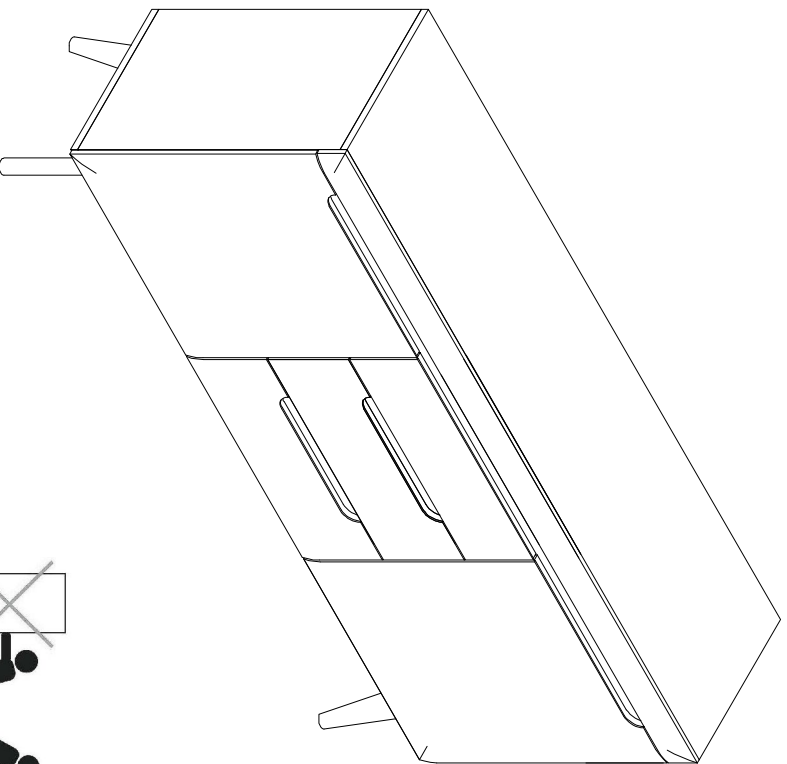

13.4.2017

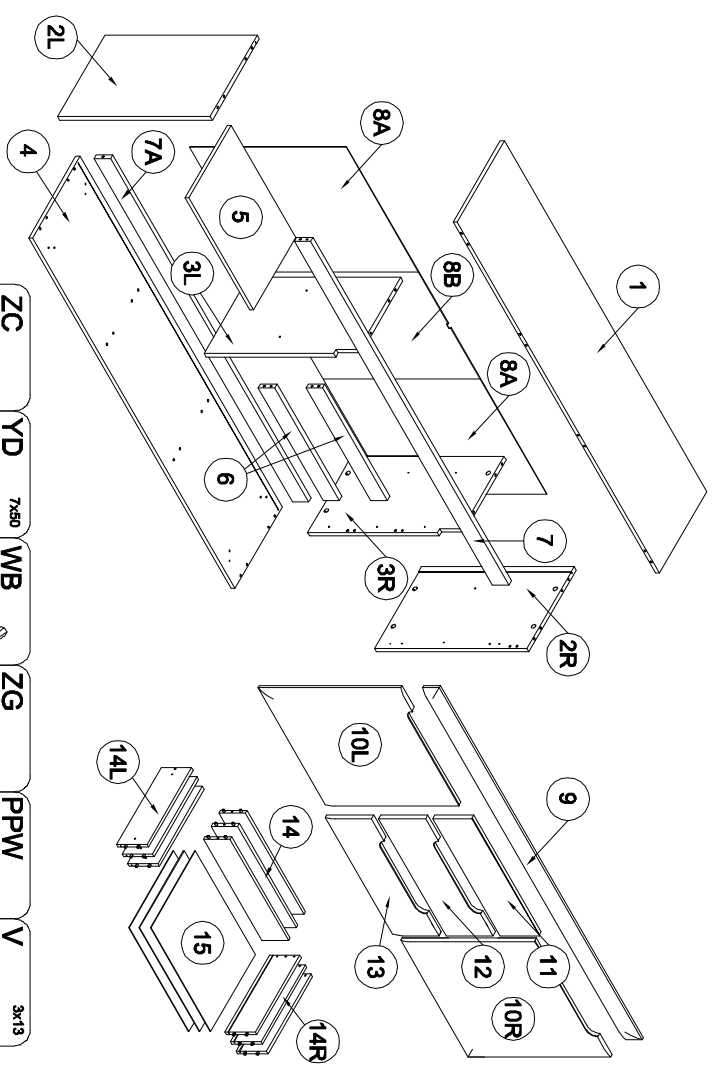

<b>B</b> X20	<b>HD</b> X8	<b>NGD</b> X4	<b>ZC</b> X8	<b>YD</b> X3	<b>WB</b> X1	<b>ZG</b> X3	<b>PPW</b> X6	<b>V</b> X18
<b>A</b> X36	<b>NGD</b> X4	<b>N</b> X8	<b>X</b> X8	<b>YD</b> X3	<b>Z</b> X1	<b>GLUE</b> X1	<b>TB</b> X1	<b>TA</b> X1
<b>R</b> X4	<b>A</b> X4	<b>N</b> X8	<b>X</b> X8	<b>YD</b> X3	<b>Z</b> X1	<b>GLUE</b> X1	<b>TB</b> X1	<b>TA</b> X1
<b>H</b> X8	<b>A</b> X4	<b>N</b> X8	<b>X</b> X8	<b>YD</b> X3	<b>Z</b> X1	<b>GLUE</b> X1	<b>TB</b> X1	<b>TA</b> X1
<b>PC</b> X4	<b>A</b> X4	<b>N</b> X8	<b>X</b> X8	<b>YD</b> X3	<b>Z</b> X1	<b>GLUE</b> X1	<b>TB</b> X1	<b>TA</b> X1
<b>ND</b> X21	<b>A</b> X4	<b>N</b> X8	<b>X</b> X8	<b>YD</b> X3	<b>Z</b> X1	<b>GLUE</b> X1	<b>TB</b> X1	<b>TA</b> X1
<b>C</b> X20	<b>A</b> X4	<b>N</b> X8	<b>X</b> X8	<b>YD</b> X3	<b>Z</b> X1	<b>GLUE</b> X1	<b>TB</b> X1	<b>TA</b> X1
<b>Z</b> X20	<b>A</b> X4	<b>N</b> X8	<b>X</b> X8	<b>YD</b> X3	<b>Z</b> X1	<b>GLUE</b> X1	<b>TB</b> X1	<b>TA</b> X1

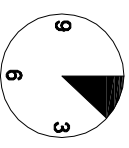

20 min.

1

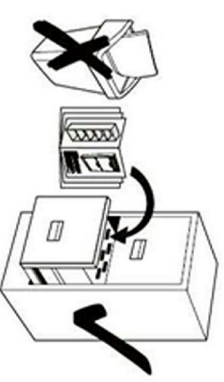
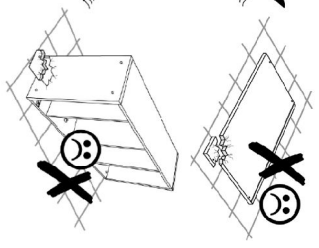
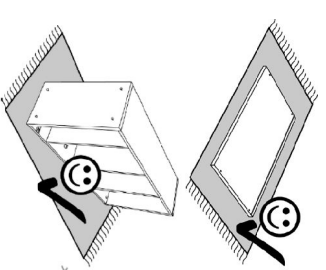

2

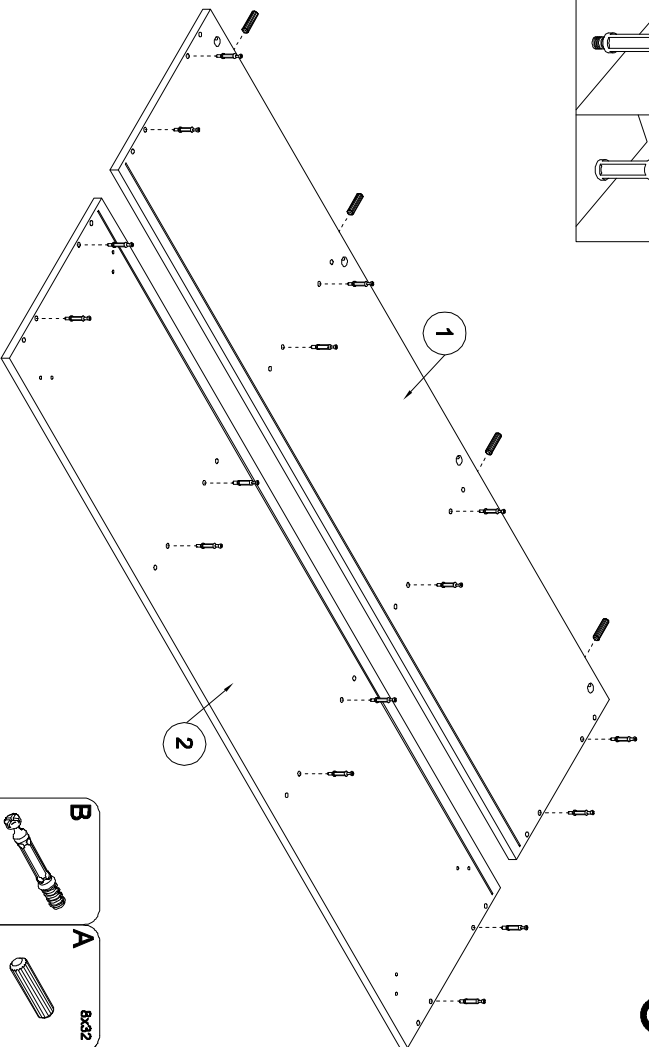
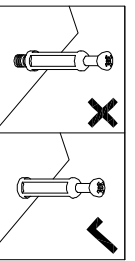

3

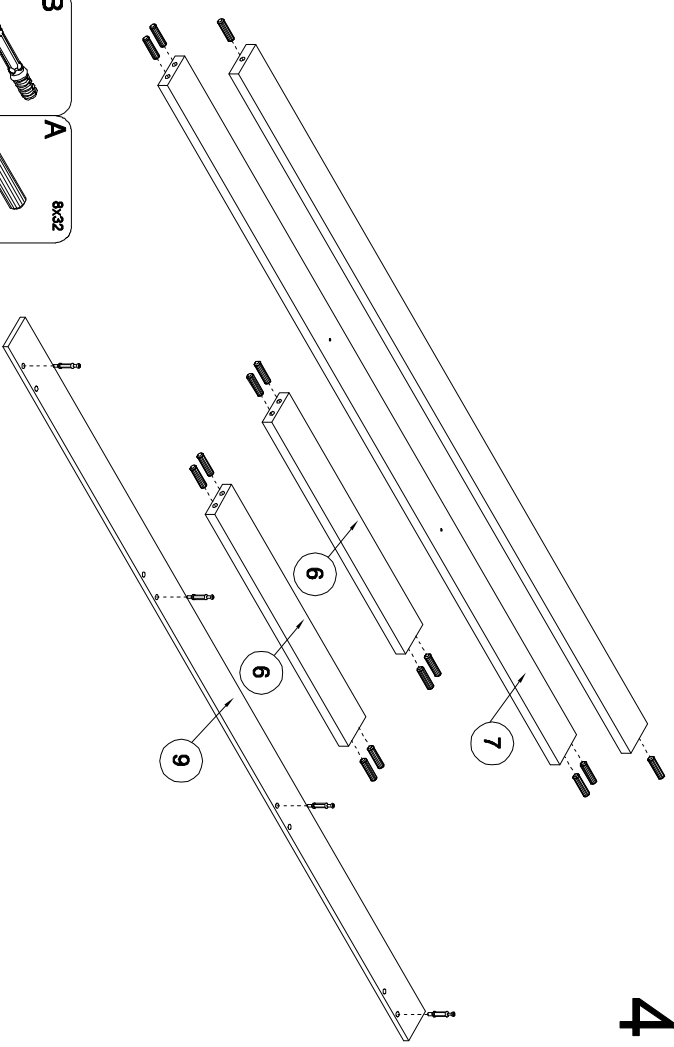
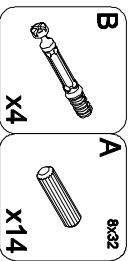
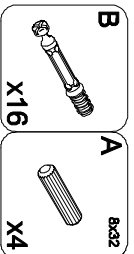

4

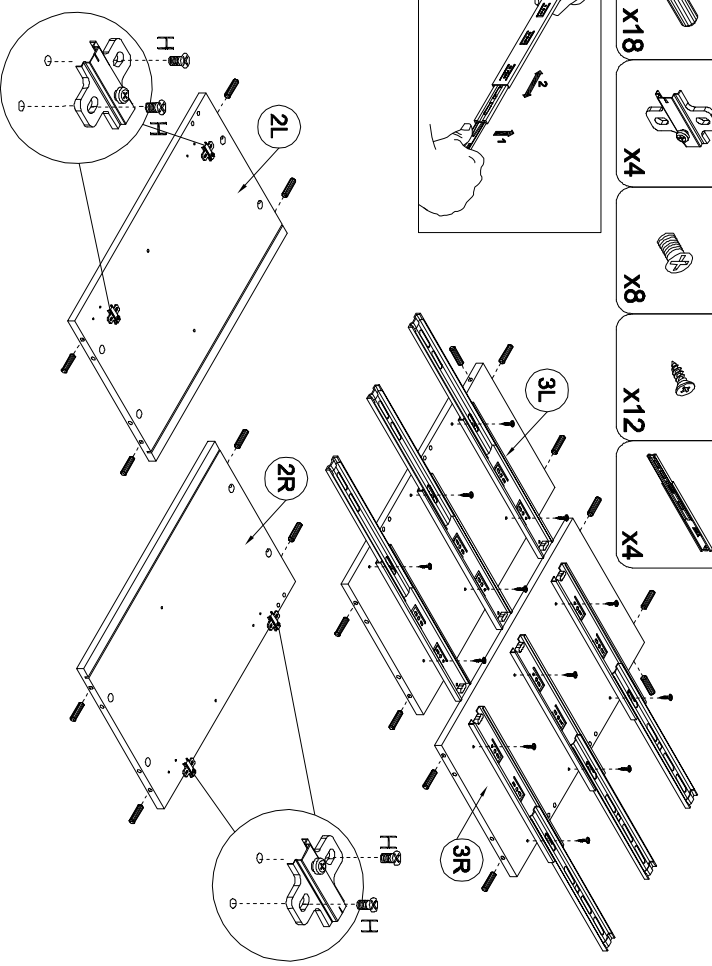
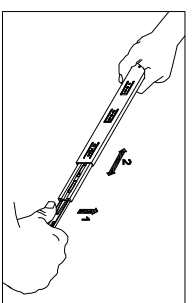

5

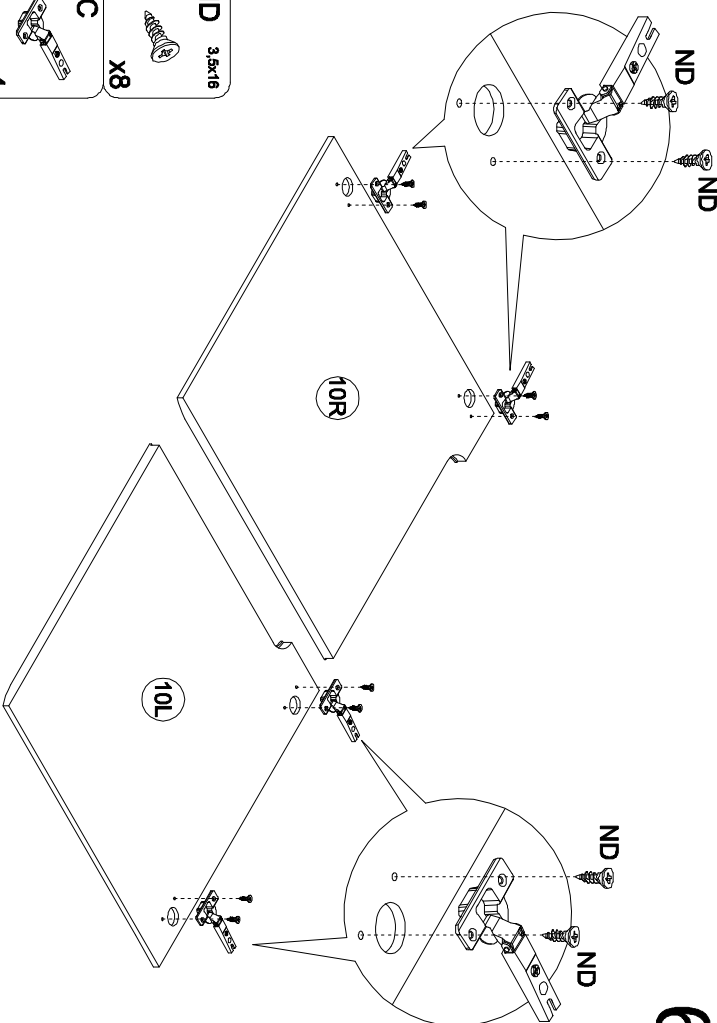
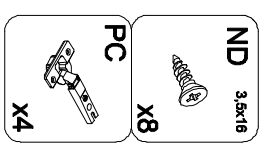

6

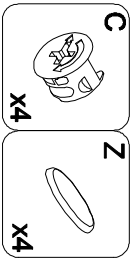
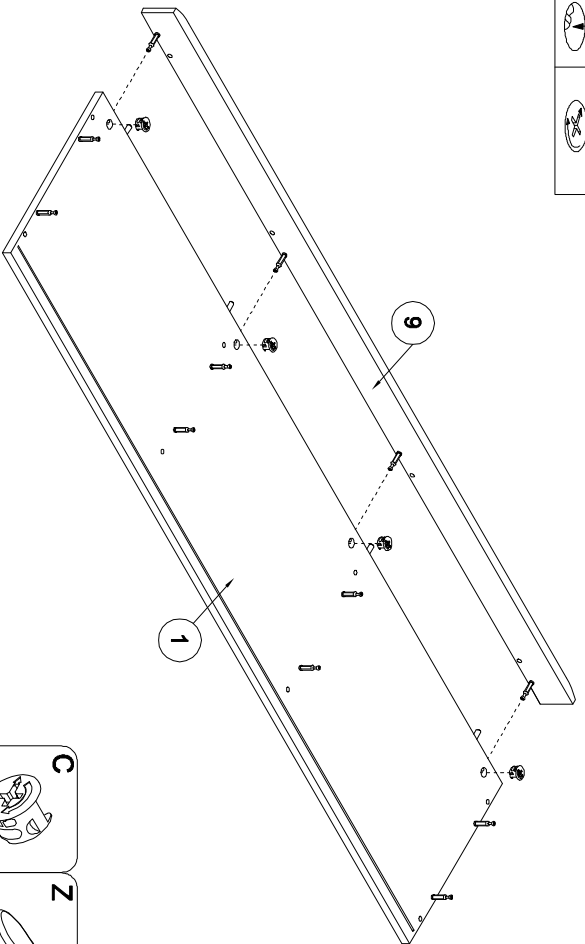
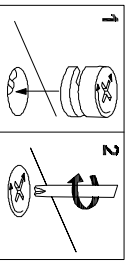

7

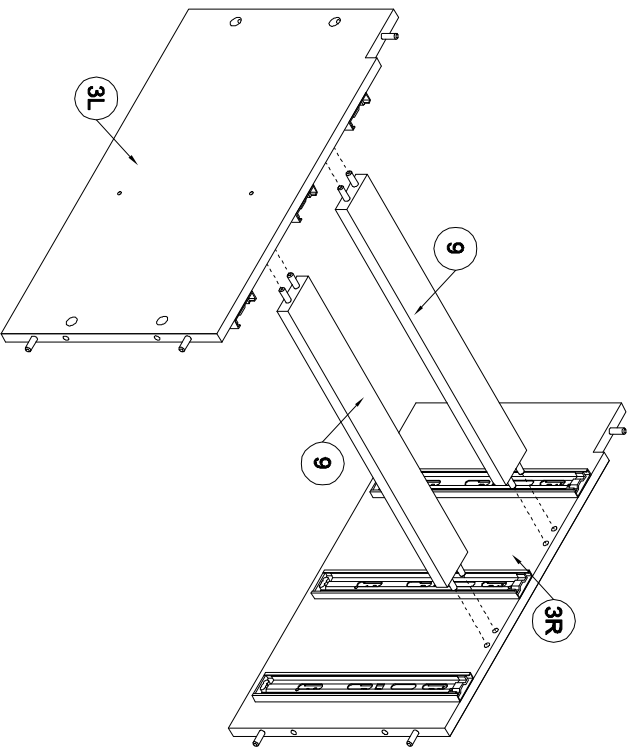

8

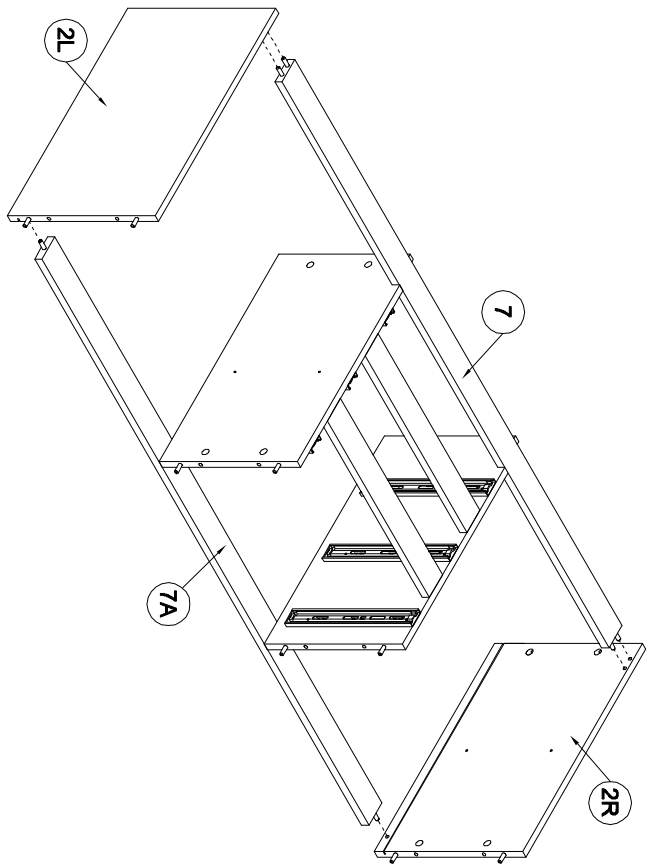

9

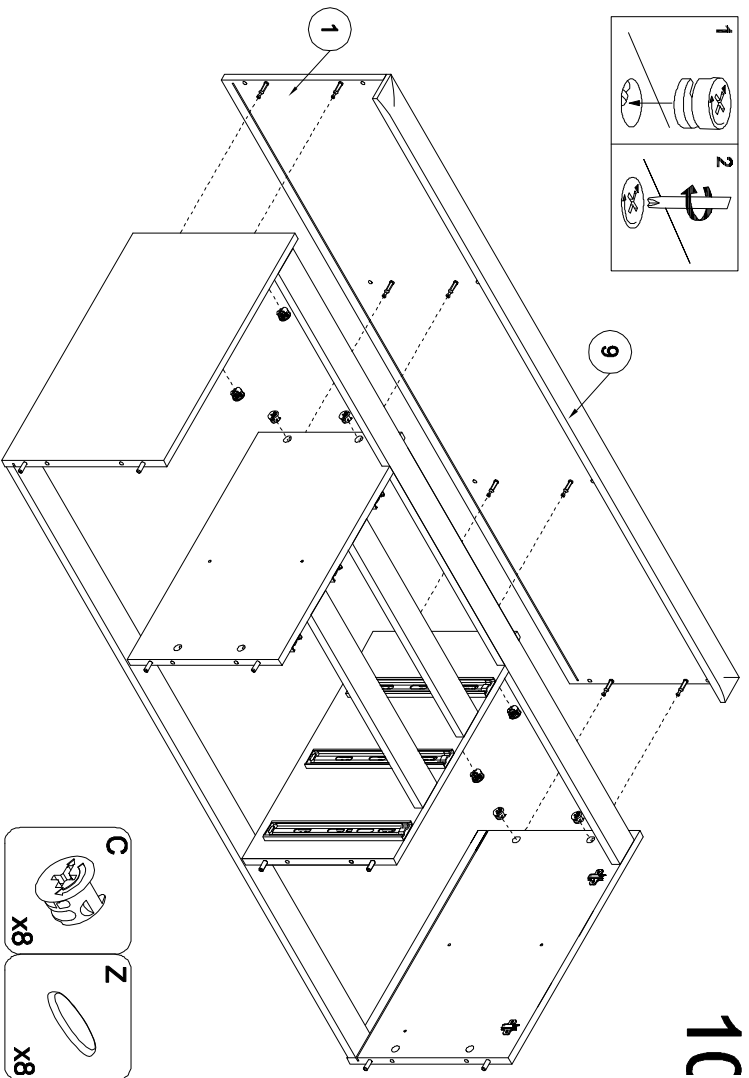
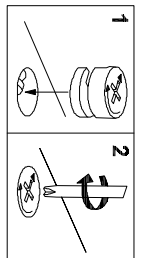

10

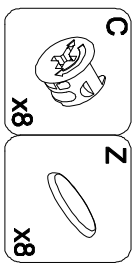

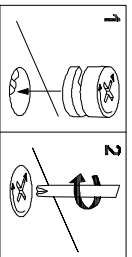

11

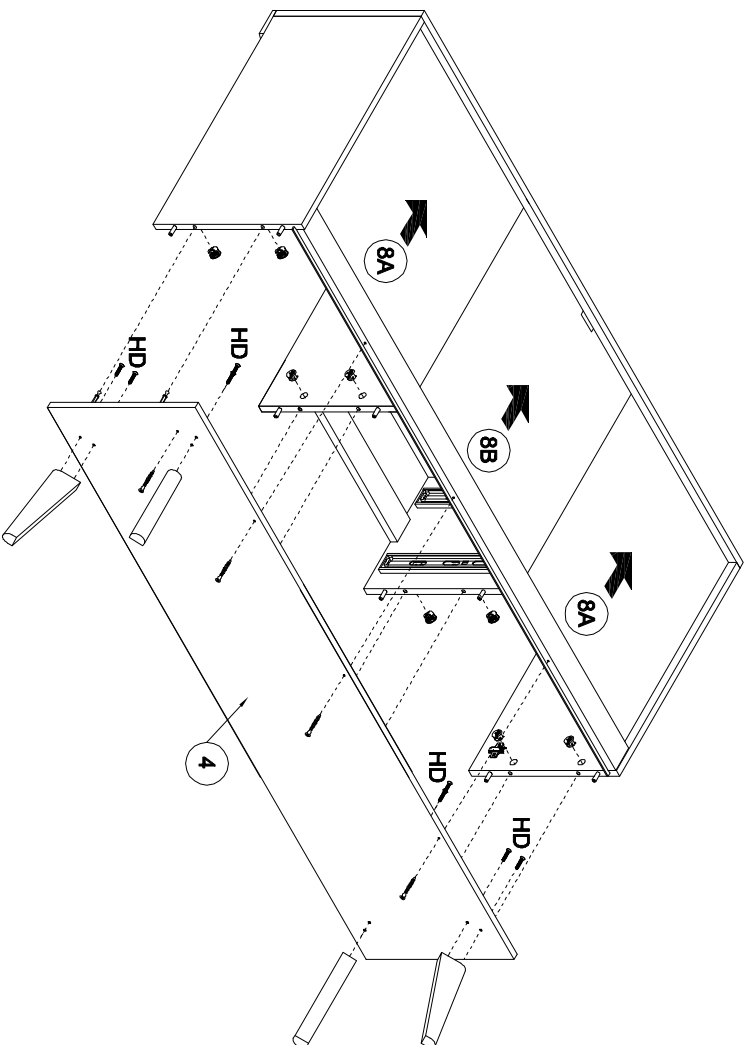

- YD** 7x50 x3
- WB** x1
- ZG** x3
- HD** x8
- NGD** x4
- C** x8
- Z** x8

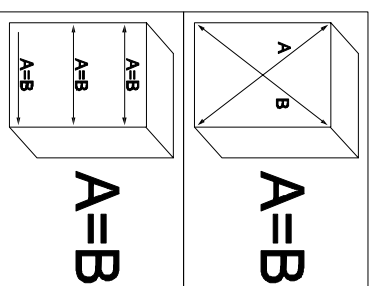

12

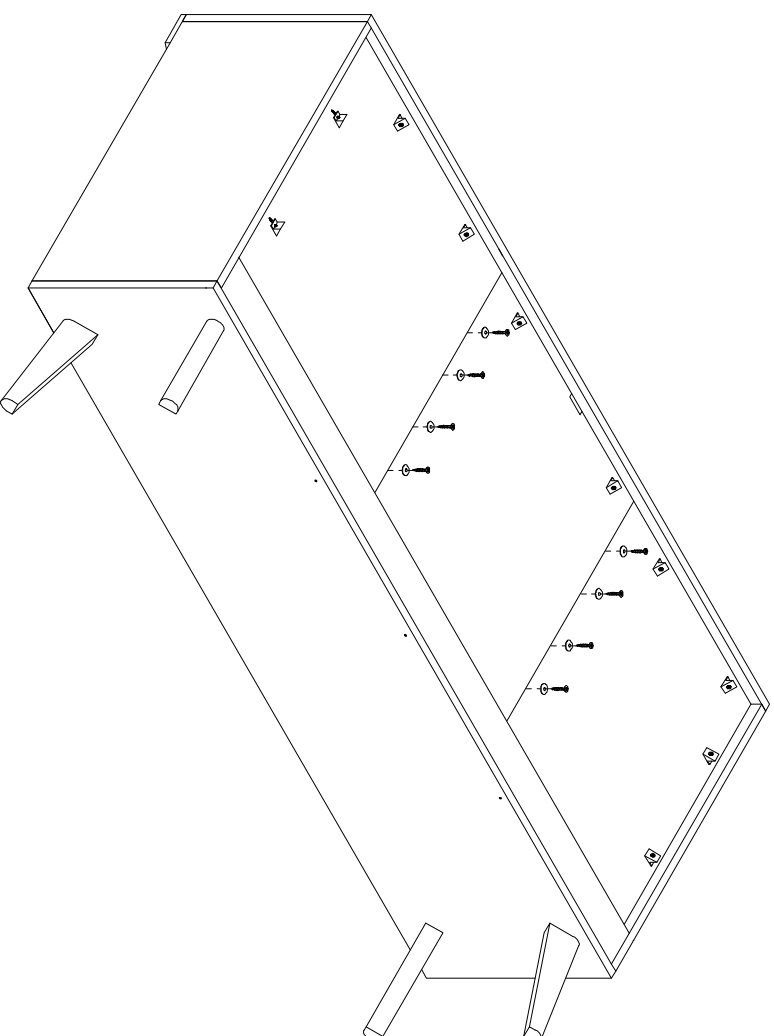

- ZC** x8
- N** 3x20 x8
- X** x10

13

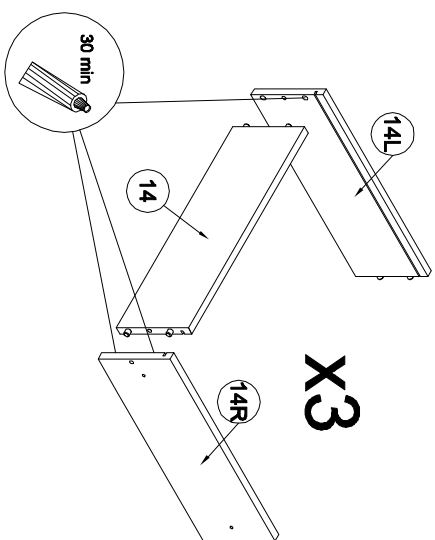



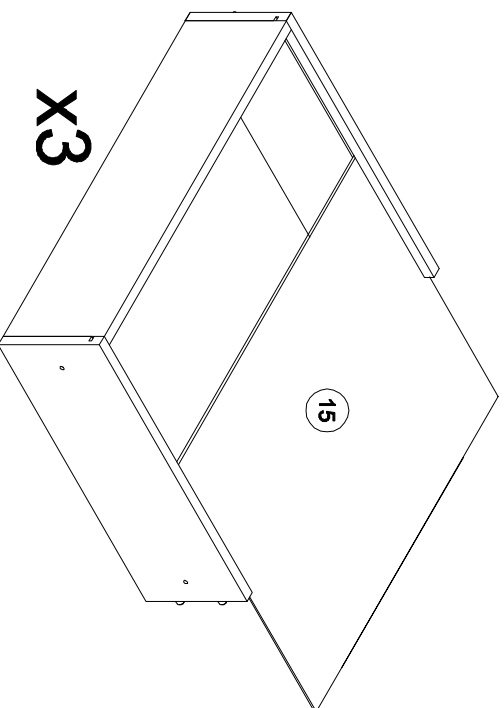

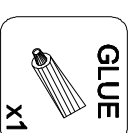
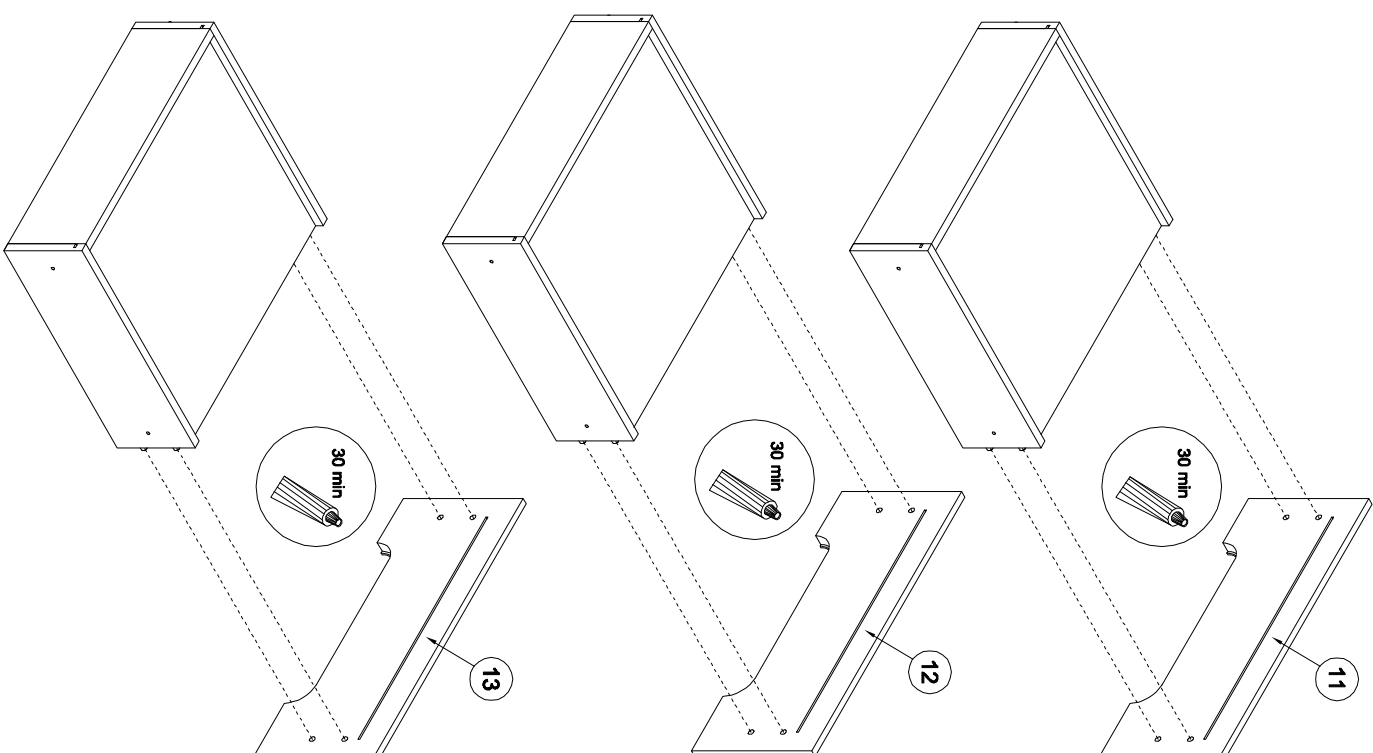

15

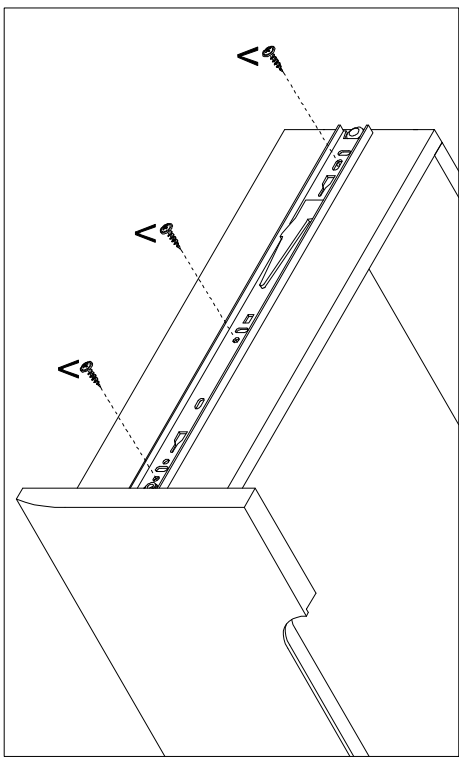
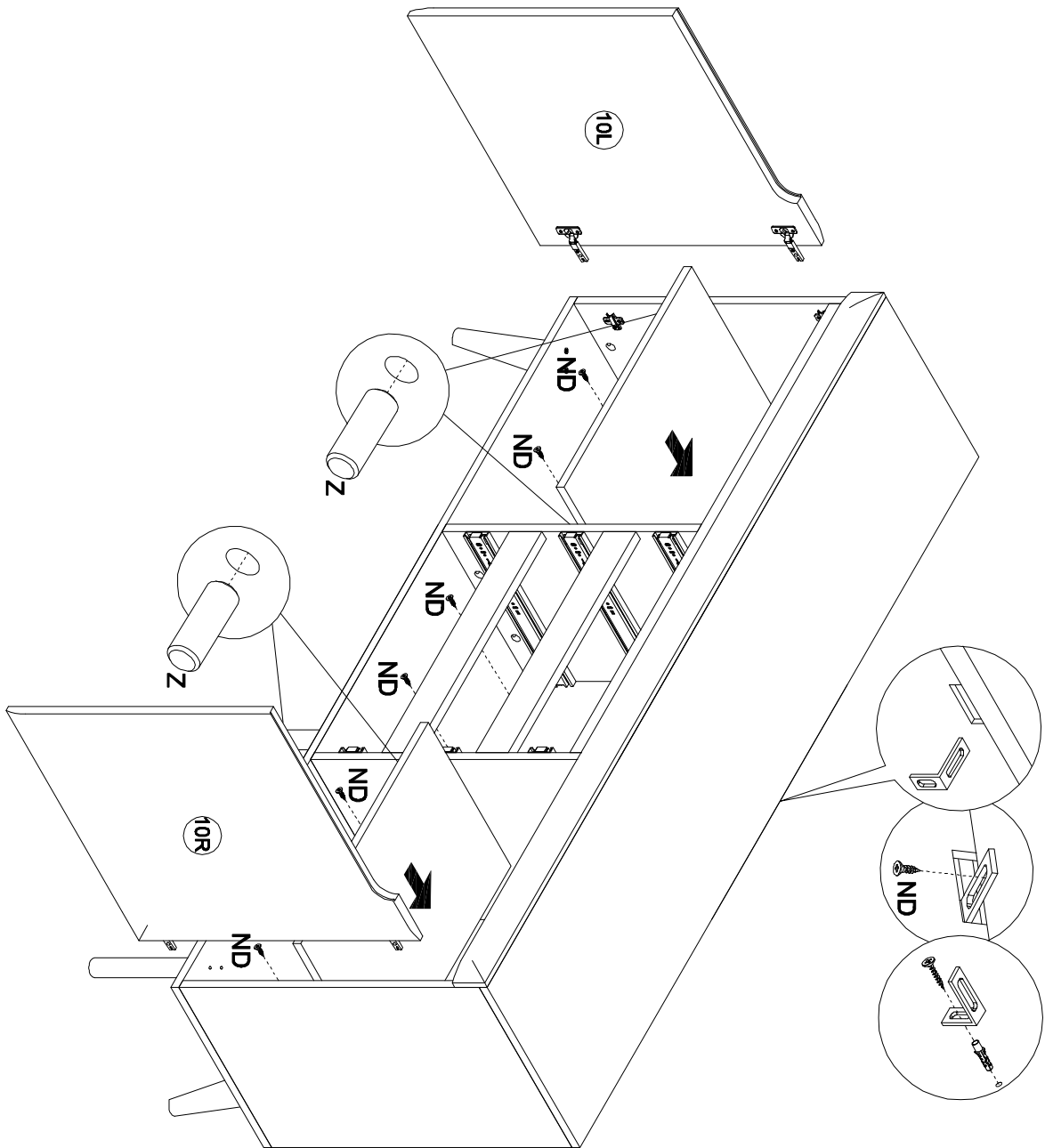
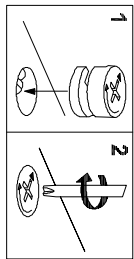
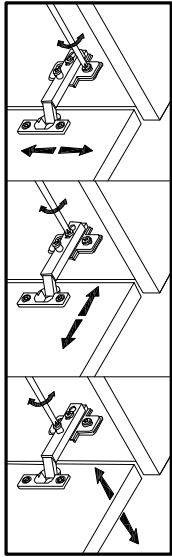

14





- TB  x1
- TA  x1
- Z  x8
- ND  3x16 x7
- V  3x13 x18

